

AT8PSN/AT8PMN Series

DIN W48 × H48mm Solid-State, Power OFF Delay Timer

■ Features

- Time setting range
(AT8PSN: 0.05 to 10 sec, AT8PMN: 0.05 to 10 min)
- Simple time setup and direct read of time range
- Power supply
: 100-120VAC 50/60Hz, 200-240VAC 50/60Hz
100/110VDC, 24VAC 50/60Hz, 24VDC universal
- Application: Protect circuit when momentary power failure and start it again



⚠ Please read "Safety Considerations" in the instruction manual before using.



■ Ordering Information

AT 8 P SN - □

AT	Item	AT	Analog Timer
8	Number of plug pins	8	8-pin plug type
P	Time operation	P	Power OFF Delay
SN	Time unit	SN	SEC
		MN	MIN
		6	100-120VAC 50/60Hz
		7	100/110VDC
		2	24VAC 50/60Hz, 24VDC
		No mark	200-240VAC 50/60Hz
	Power supply		

※8-pin socket (PG-08, PS-08(N)) is sold separately.

■ Specifications

Model		AT8PSN-□	AT8PMN-□
Function		Power OFF Delay	
Control time setting range ^{※1}		0.05 to 10 sec	0.05 to 10 min
Power supply		• 100-120VAC~ 50/60Hz • 100/110VDC=	• 200-240VAC~ 50/60Hz • 24VAC~ 50/60Hz, 24VDC= universal
Allowable voltage range		90 to 110% of rated voltage	
Power consumption		• Max. 1.5VA (100-120VAC~) • Max. 0.8W (100/110VDC=)	• Max. 1.5VA (200-240VAC~) • Max. 2VA (24VAC~), Max. 2W (24VDC=)
Timing operation		Power OFF start	
Control output	Contact type	Time limit DPDT (2c)	
	Contact capacity	250VAC~ 3A, 30VDC= 3A resistive load	
Relay life cycle	Mechanical	Min. 10,000,000 operations	
	Electrical	Min. 100,000 operations (250VAC 3A resistive load)	
Repeat error		Max. ±0.2% ±10ms	
SET error		Max. ±5% ±50ms	
Voltage error		Max. ±0.5%	
Temperature error		Max. ±2%	
Insulation resistance		Over 100MΩ (at 500VDC megger)	
Dielectric strength		2,000VAC 50/60Hz for 1 min	
Noise immunity		±2kV the square wave noise (pulse width: 1μs) by the noise simulator	
Vibration	Mechanical	0.75mm amplitude at frequency of 10 to 55Hz (for 1 min) in each X, Y, Z direction for 1 hour	
	Malfunction	0.5mm amplitude at frequency of 10 to 55Hz (for 1 min) in each X, Y, Z direction for 10 min	
Shock	Mechanical	300m/s ² (approx. 30G) in each X, Y, Z direction 3 times	
	Malfunction	100m/s ² (approx. 10G) in each X, Y, Z direction 3 times	
Environment	Ambient temperature	-10 to 55°C, storage: -25 to 65°C	
	Ambient humidity	35 to 85%RH	
Approval		CE, c, UL US	
Accessory		Bracket	
Unit weight		Approx. 100g	

※1: Refer to time specifications for control time setting range.

※Environment resistance is rated at no freezing or condensation.

Power OFF Delay Analog Timer

Connections

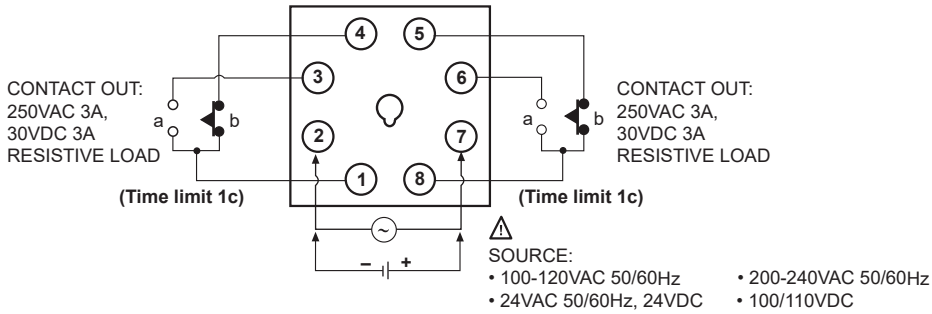

Dimensions

(unit: mm)

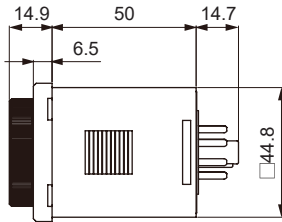
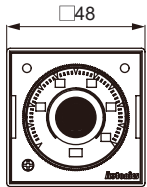

Bracket

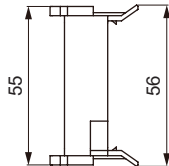
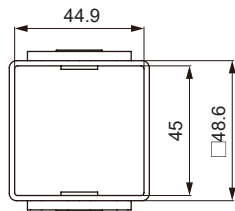
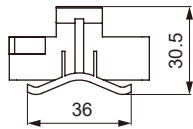

Panel cut-out

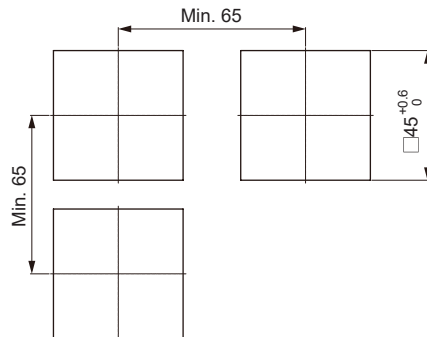

Unit Description

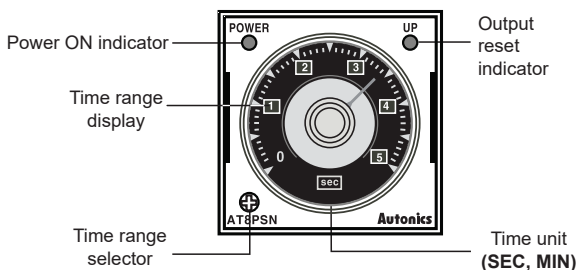

Time specifications

Model	Time range	Time unit	Time setting range
AT8PSN-□	0.5	SEC	0 to 0.5 sec
	1		0 to 1 sec
	5		0 to 5 sec
	10		0 to 10 sec
AT8PMN-□	0.5	MIN	0 to 0.5 min
	1		0 to 1 min
	5		0 to 5 min
	10		0 to 10 min

SENSORS
CONTROLLERS
MOTION DEVICES
SOFTWARE

(J) Temperature Controllers
(K) SSRs
(L) Power Controllers
(M) Counters
(N) Timers
(O) Digital Panel Meters
(P) Indicators
(Q) Converters
(R) Digital Display Units
(S) Sensor Controllers
(T) Switching Mode Power Supplies

(U) Recorders
(V) HMIs
(W) Panel PC
(X) Field Network Devices

AT8PSN/AT8PMN Series

■ Output Operation Mode

Contact a turns ON when the power applied and then turns off after setting time (T) is passed when the power off. There is memory protection function. Even though changing setting time after cutting the power, time limit a contact turns OFF after the setting time before cutting the power.

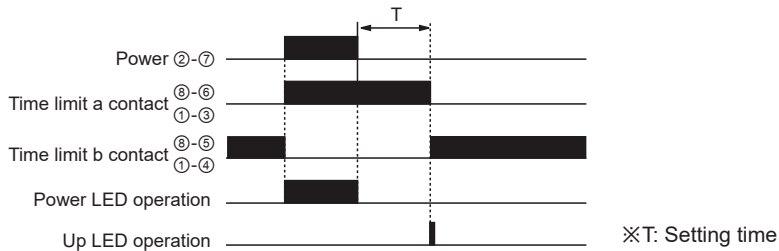

■ Proper Usage

- Follow instructions in 'Proper Usage'. Otherwise, it may cause unexpected accidents.
- 24VDC, 24VAC power supply should be insulated and limited voltage/current or Class 2, SELV power supply device.
- Supply power for over 0.1 sec for AT8PSN-□ and 2 sec for AT8PMN-□.
Since AT8PSN/PMN are Power Off Delay timer, they operate after turning of the power.
- When supplying or turning off the power, use a switch or etc. to avoid chattering.
- Install a power switch or circuit breaker in the easily accessible place for supplying or disconnecting the power.
- Keep away from high voltage lines or power lines to prevent inductive noise.
In case installing power line and input signal line closely, use line filter or varistor at power line and shielded wire at input signal line.
Do not use near the equipment which generates strong magnetic force or high frequency noise.
- Change setting time(T1) or etc. after turning off the power of the timer.
- This product may be used in the following environments.
 - ① Indoors (in the environment condition rated in 'Specifications')
 - ② Altitude max. 2,000m
 - ③ Pollution degree 2
 - ④ Installation category II